

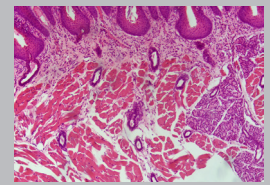

H4KWS08DPX

3 IN 1 MICROSCOPE CAMERA

- ▶ 4K resolution
- ▶ On screen measurement
- ▶ 4K Video record
- ▶ Digital Classroom with APP
- ▶ HDMI, USB, GE and WiFi

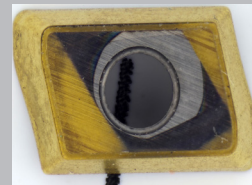
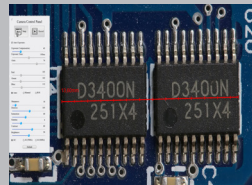
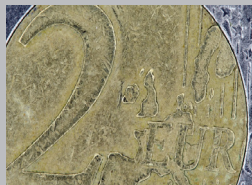
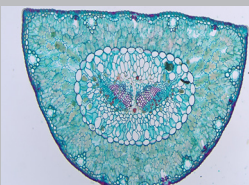

H4KWSD08DPX

The H4KWSD08DPX produces high-resolution images with vibrant natural colors suited also for critical applications like Pathology and likewise plus it has a state of the art built-in measurement software providing highly effective measurement tools directly on the screen with no need for a computer.

With the H4KWSD08DPX users can enjoy fast, comfortable, and user-friendly on-screen operation – improving sample evaluation, measurement, facilitating effective collaborations, and documentation in high resolution. For more advanced applications the user has the option to connect the camera to a PC via USB 3.0, GE, or WiFi and use DeltaPix InSight in order to make further analysis. Moreover, this camera provides a completely new platform for educational applications because it can stream the video to android smartphones making it super easy to share images and videos with the students



High quality, cost effective and flexible

The DeltaPix H4KWSD08DPX microscope camera has C-mount interface making them easily and cost-efficiently fitted on most standard microscopes. Additionally, it has multiple interfaces providing unmatched versatility for any use case.



User-friendly Camera

Plug and play – the HDMI interface provides high speed and ease of installation on any 4K monitor with HDMI input.

No need for computer, because the H4KWSD08DPX microscope camera has a built-in software. Option to use it with PC software or Smartphone app.



Typical applications: ✓ Documentation and publishing ✓ Material science ✓ Metrology ✓ Quality control ✓ Dark Field ✓ Bright Field ✓ Histology ✓ Pathology ✓ Semiconductor inspection ✓ Digital Classroom

Spectral Sensitivity

Spectral Sensitivity Characteristics

(Excludes lens characteristics and light source characteristics.)

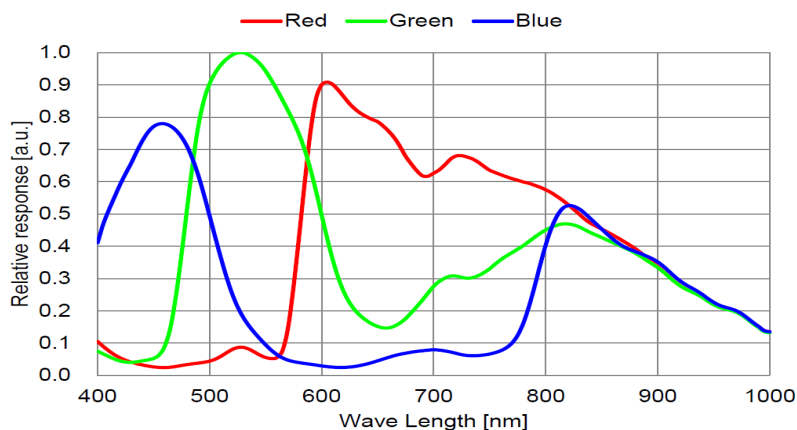

Why choose H4KWSD08DPX?

DeltaPix Build-in Software

The H4KWSD08DPX camera has the state of art software built-in software that provides a powerful platform for precise measurements, image capturing, and video recording.

Onboard measurement tools:

- Angle
- Four point angle
- Point
- Arbitrary line
- Three point line
- Horizontal line
- Vertical line
- Parallel
- Three point vertical
- Rectangle
- Curve
- Ellipse
- Five point ellipse
- Three point circle
- Center + radius circle
- Arc
- Text
- Polygon
- Annulus

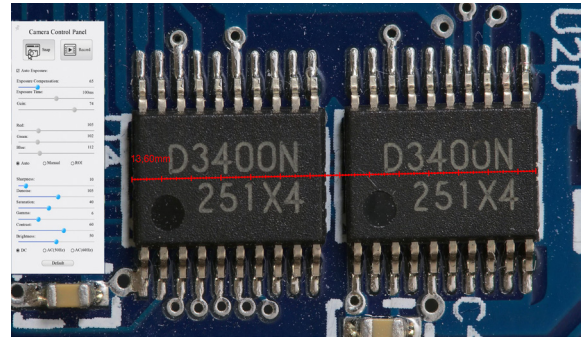

Camera Dimensions

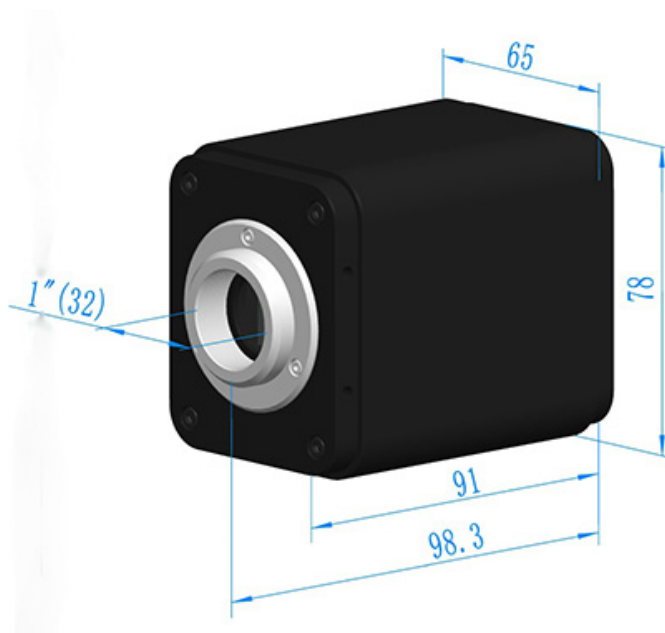

Features

H4KWSD08DPX	
	H4KWSD08DPX
Live preview resolution	3840 x 2160 @60FPS (HDMI) 1920 x 1080 @60FPS (HDMI) 3840 x 2160 @30FPS (USB 3.0) 3840 x 2160 @30FPS (WiFi)
Still image resolution	8.3Mpixels (3840x2160)
Record video	4K Video
Software	Built-in, UI in English /Chinese / Korean / Thai / French / German / Japanese / Italian InSight Basic (Included) *Free Android APP
Sensor size	1/1.8" Sony back illuminated Exmor sensors 7.68mm x 4.32mm
Pixel size	2µm x 2µm
G Sensitivity Dark Current	505mv with 1/30s 0.1mv with 1/30s
Exposure mode	Automatic or Manual
Color balance	Automatic, Manual or ROI
Interface	HDMI2.0, USB 3.0, *WiFi and *GE
Data format	Still image, JPEG or Tiff H264 encoded video
Minimum requirements	4K/Full HD monitor with HDMI input
Accessories	Mouse, tripod mount adapter, 32GB High speed SD card and 12V power supply.

*Coming soon

DeltaPix Aps, Hassellunden 16,
DK-2765 Smorum Denmark
Telephone:+45 46760205
E-mail: deltapix@deltapix.dk